

BA BAUKONSTRUKTION II

GRUNDLAGEN 2.SEMESTER

Café auf dem NDSM - Areal Amsterdam

Baukonstruktion und Entwerfen

Prof. Dennis Mueller

ss 2017

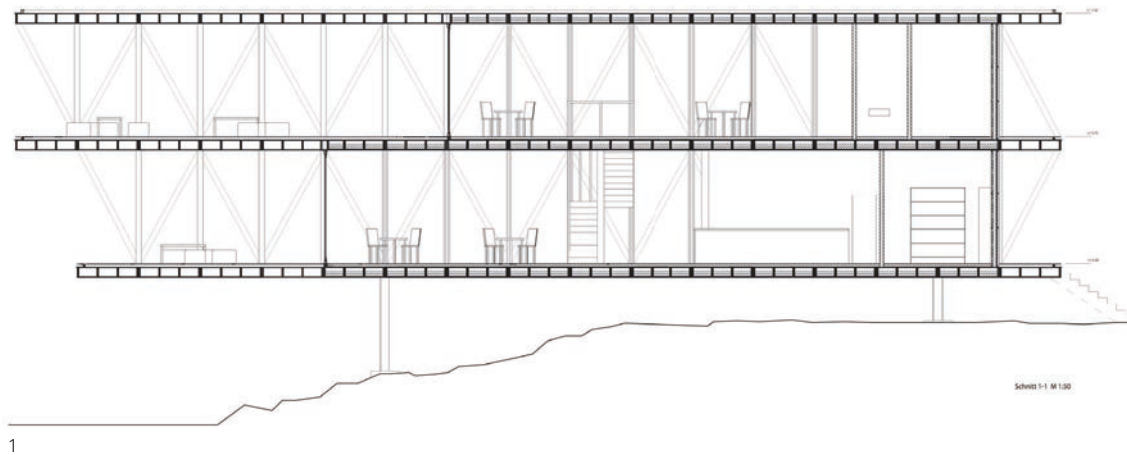

1

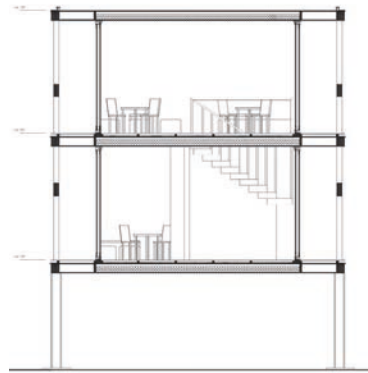

2



3

**BA 2
CAFE AMSTERDAM**

Erika Okura
Jana Hübers
Jule Blomberg

1 Längsschnitt
2 Querschnitt
3 Modellfotos

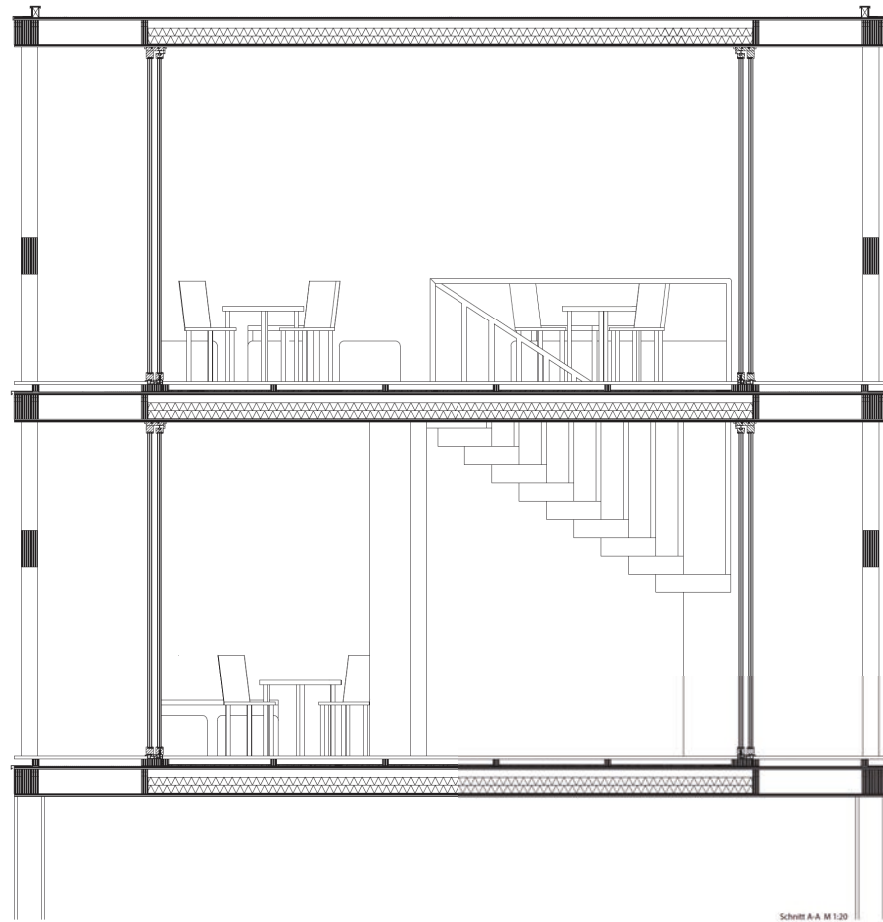

Schnitt AA M 1:20

Grundlagen der Baukonstruktion II
 BA 2 SS 2017
 Professor Dennis Müller
 Christin Löttersen, Berlin

1

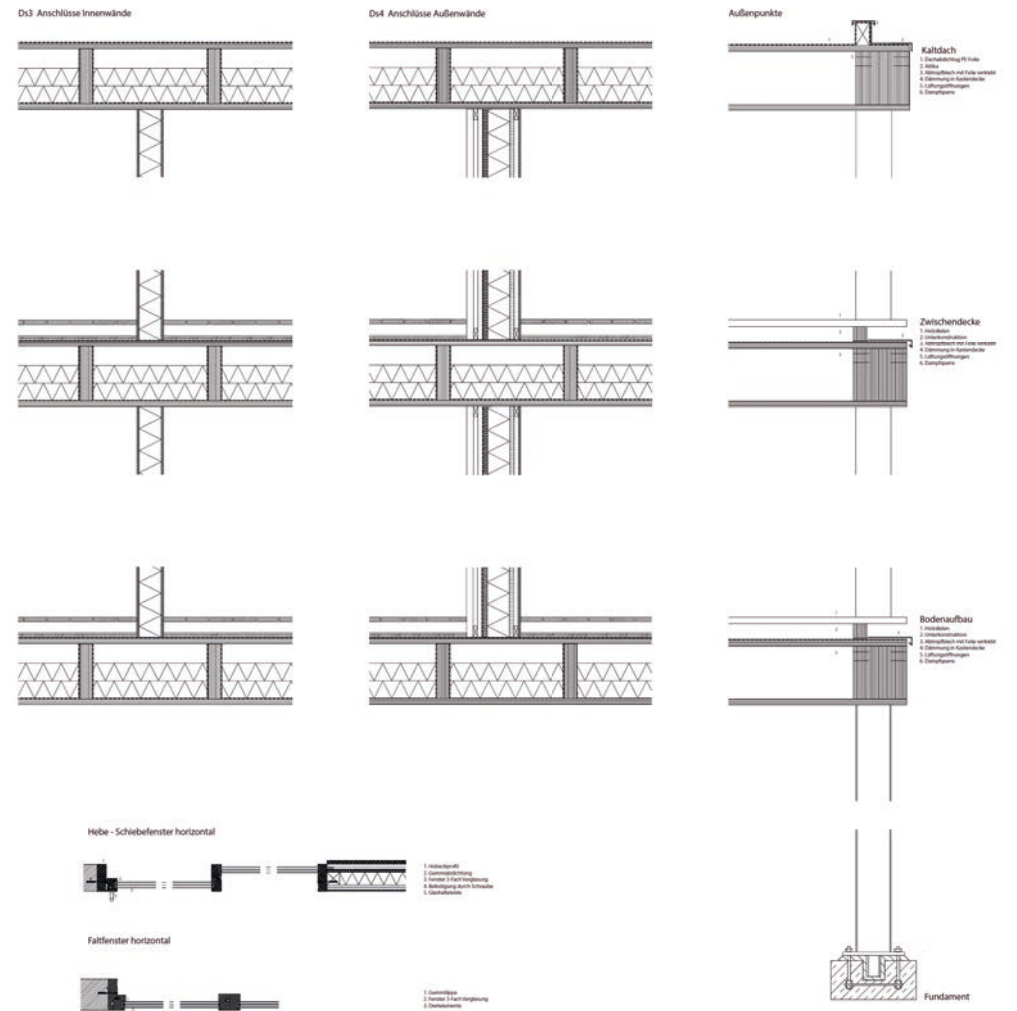

2

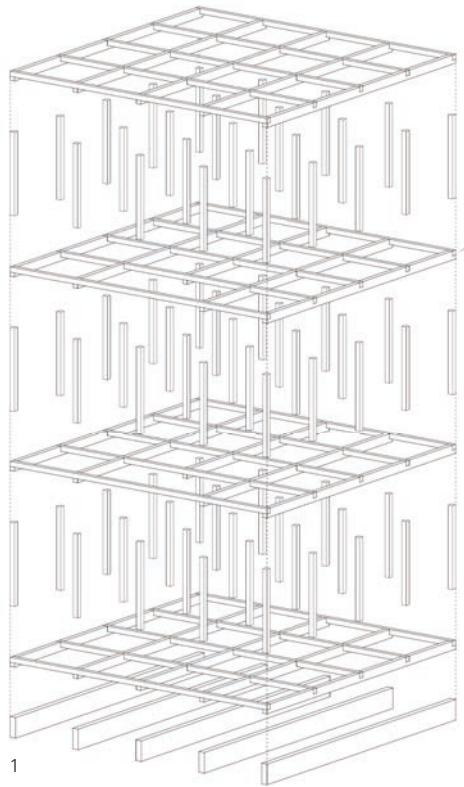

1

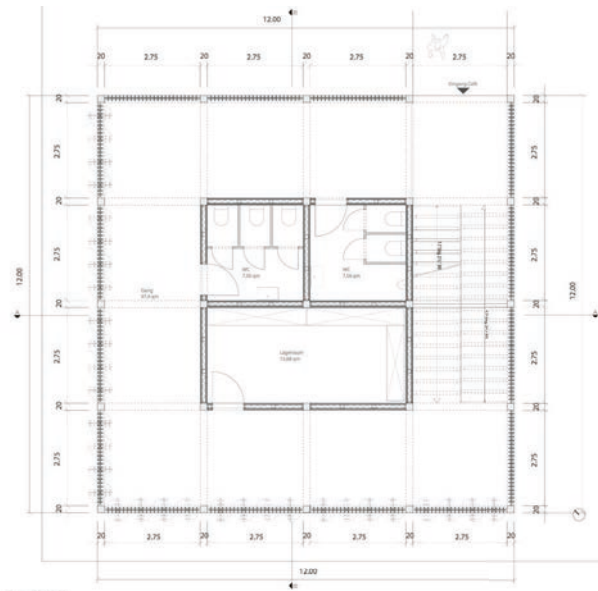

2



3

**BA 2
CAFE AMSTERDAM**

Phil Graalman
Ben Schumann
Julian Blönnigen

1 Sprengisometrie
2 Grundriss Erdgeschoss
3 Modellfotos

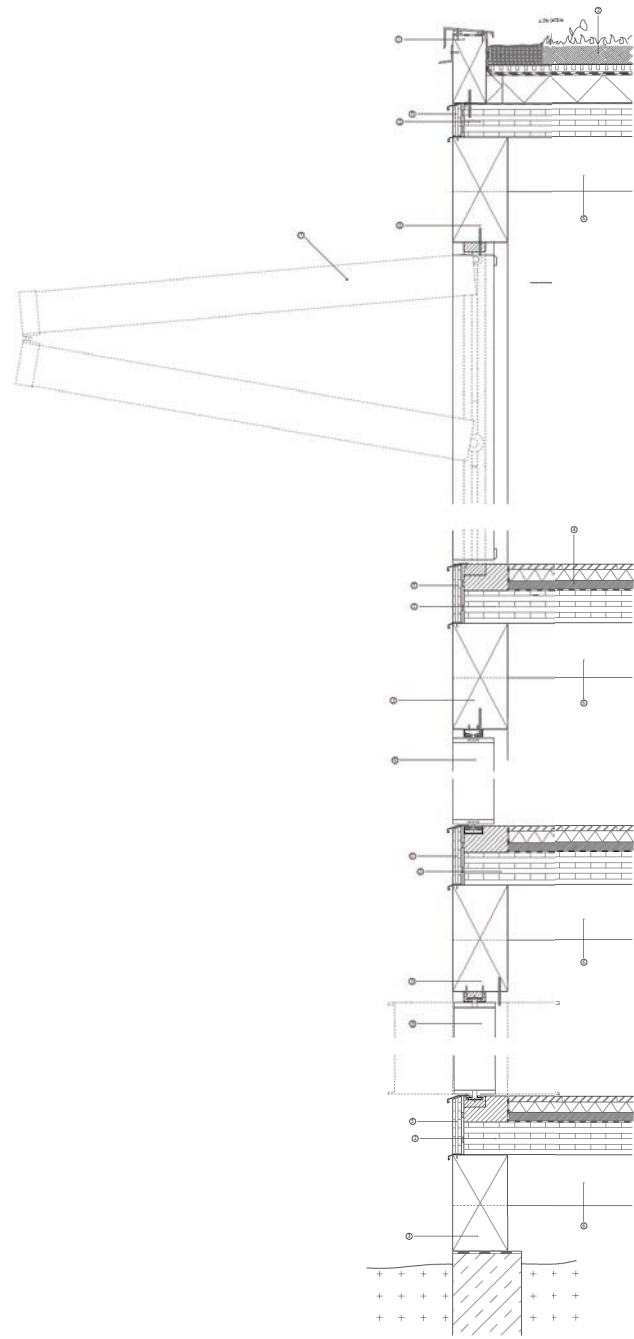

- Detailanschnitt Längsschnitt 1:10**
1. Außenputz
 2. Putz
 3. Putz
 4. Putz
 5. Putz
 6. Putz
 7. Putz
 8. Putz
 9. Putz
 10. Putz

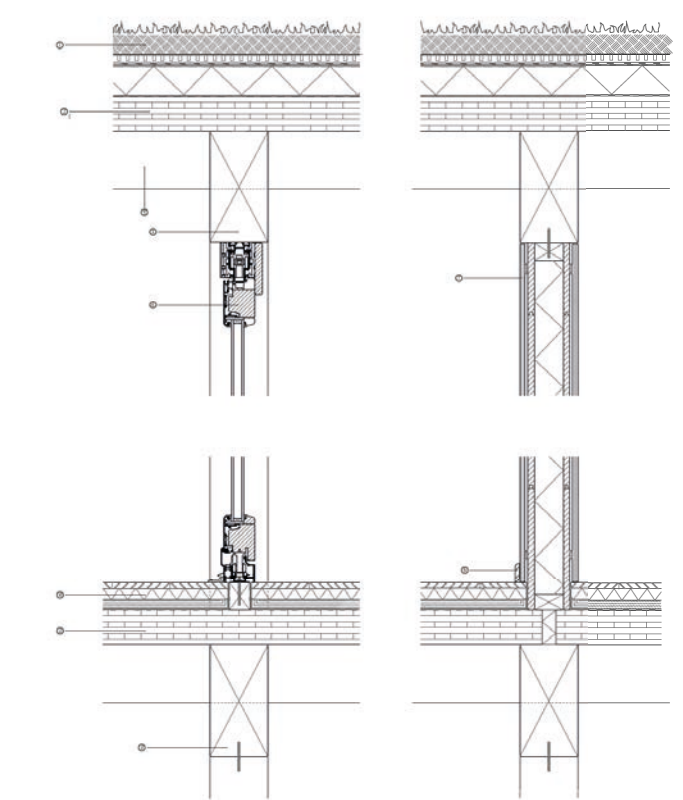

- Vertikalschnitt Längsschnitt einer angestellten Fensterbank 1:10**
1. Fensterrahmen
 2. Fensterrahmen
 3. Fensterrahmen
 4. Fensterrahmen
 5. Fensterrahmen
 6. Fensterrahmen
 7. Fensterrahmen
 8. Fensterrahmen
 9. Fensterrahmen
 10. Fensterrahmen

2

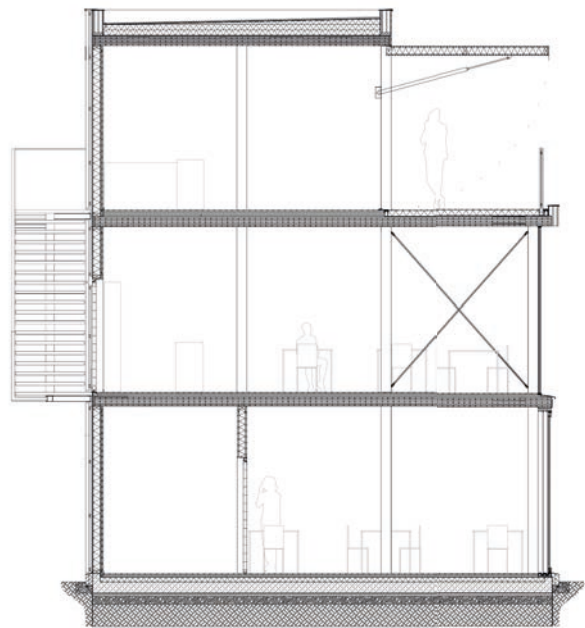

1

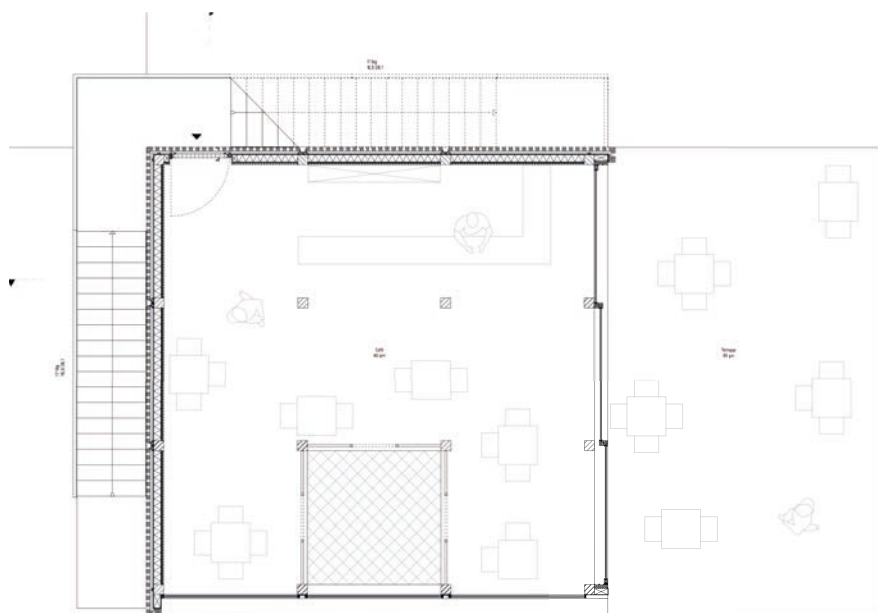

2



3

**BA 2
CAFE AMSTERDAM**

Maren Krefeld
Clara Simon
Ricarda Seidenstücker

1 Schnitt
2 Grundriss 1.Obergeschoss
3 Modellfotos

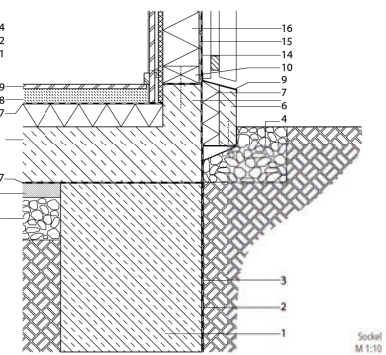
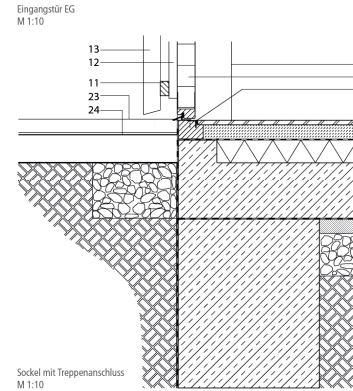
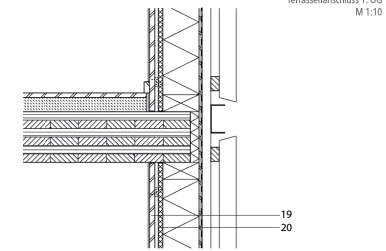
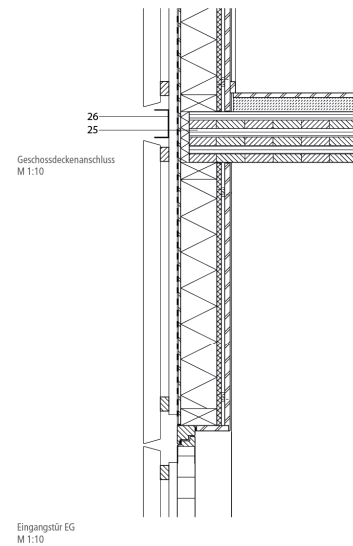
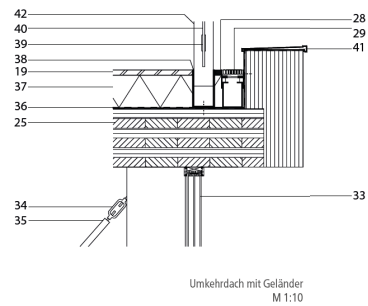
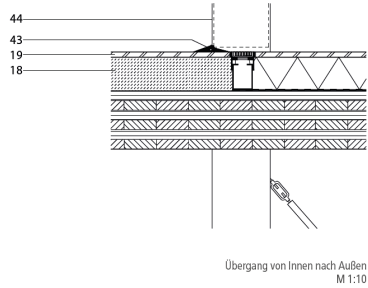
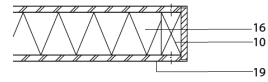
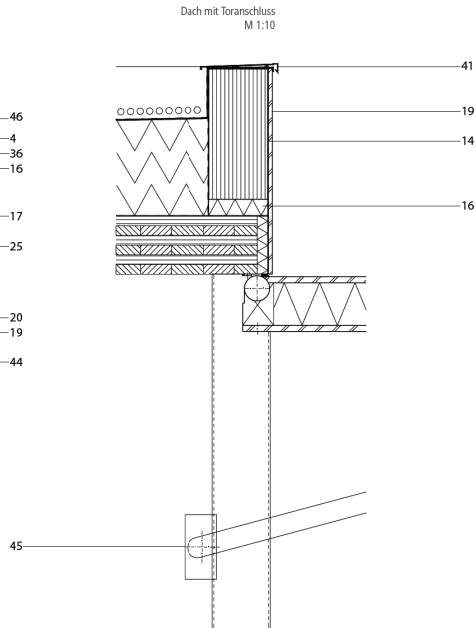
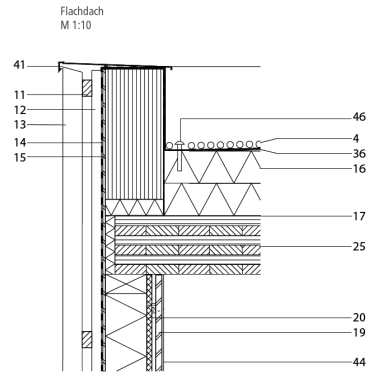

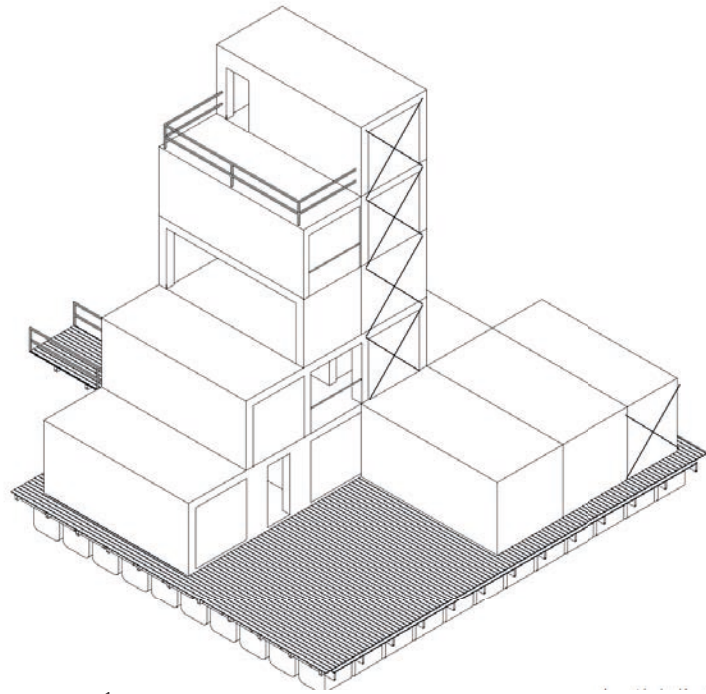

1

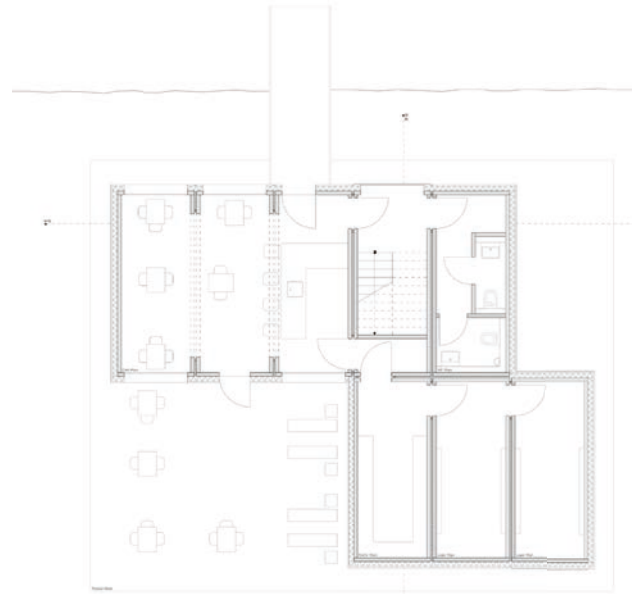

2

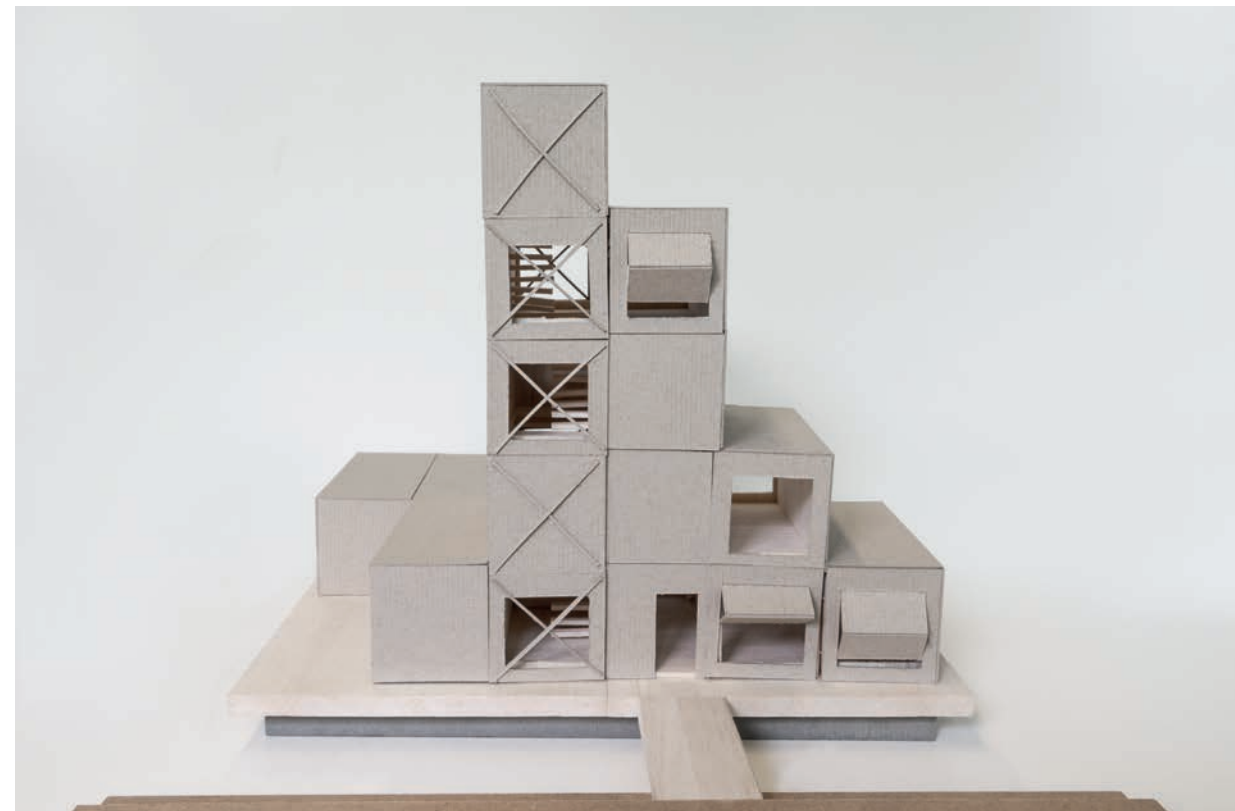

3

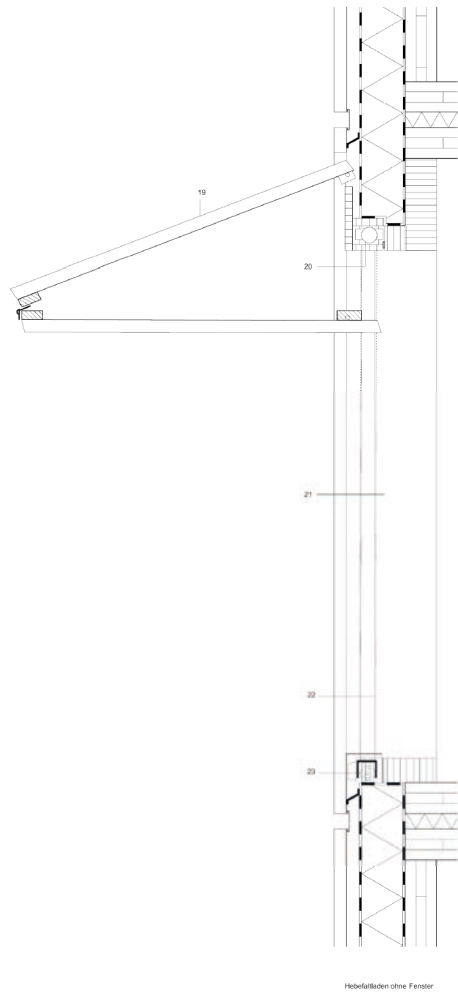

Höbelbau ohne Fenster

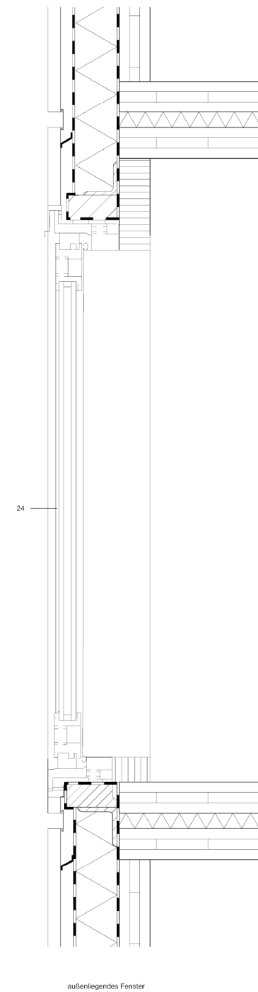

außenliegendes Fenster

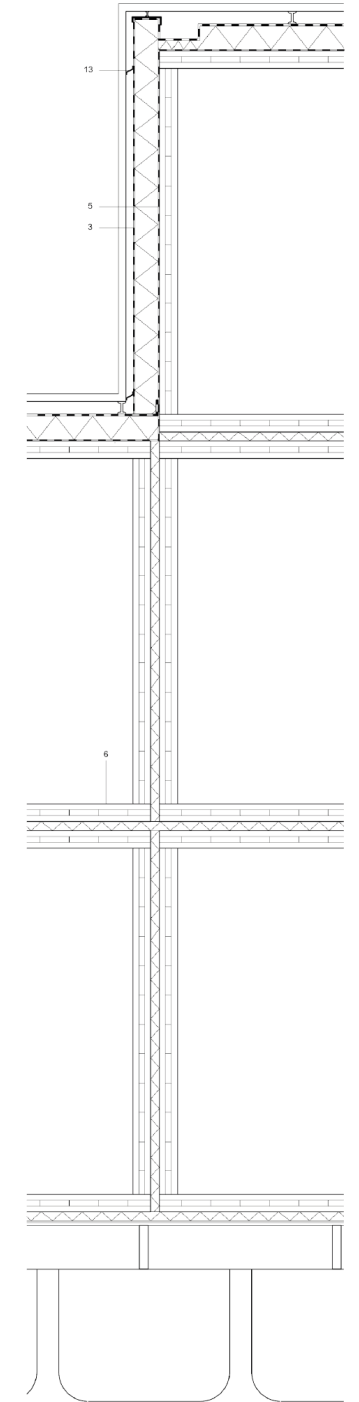
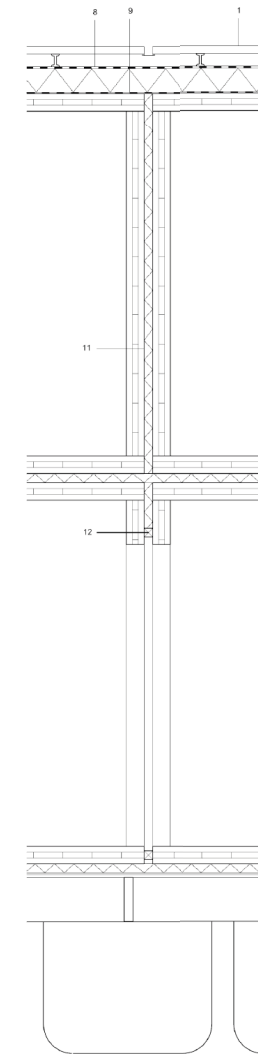
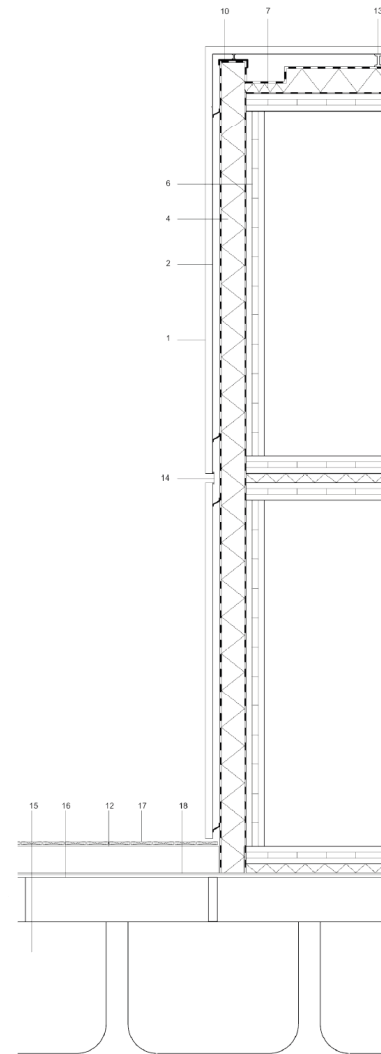

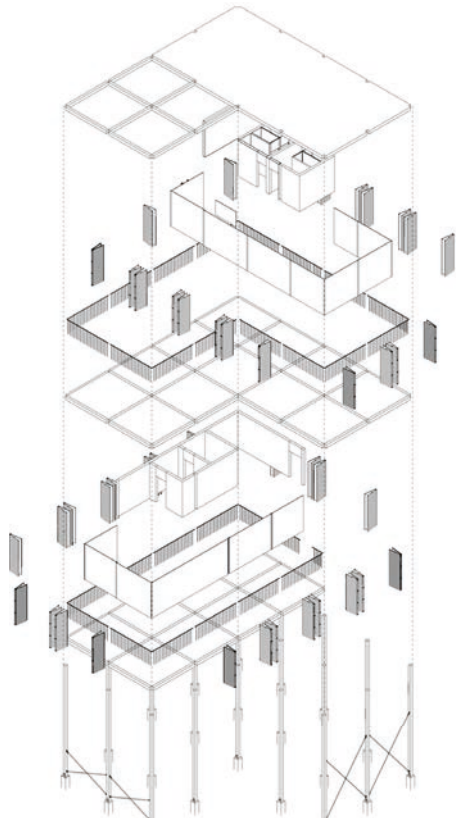

1

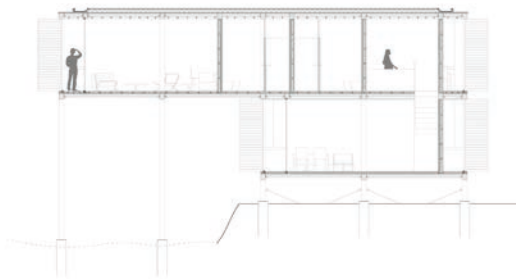

2



3

